

WINGS SURFACE

D82018

GENERAL

Series: Wings
Brand: Panzeri
Division: Design
Mounting Type: Surface
Mounting Location: Ceiling
Subcategory: Ambient

PHYSICAL

Shape: Abstract
Length (mm): 290
Length (in): 11 1/2
Height (mm): 200
Height (in): 7 3/4
Light Distribution: Omnidirectional
Weight (kg): 1.23
Weight (lbs): 2.7
Diffuser: Matte White Printed Pyrex
Fixture Finish: Metallic Gray
Fixture Material: Metal

ELECTRICAL

Number of Lamps: 1
Lamp Type: LED Retrofit / Halogen
Bulb Included: Bulb Not Included
Total Output Wattage (W): 30 / 200
Max. Wattage Per Lamp (W): 30 / 200
Lamp Base: R7s
Input Voltage (V): 120

LED

OPTICAL

RATINGS AND CERTIFICATIONS

Certified By: CSA Certified to UL and CSA Standards
IP rating: IP40

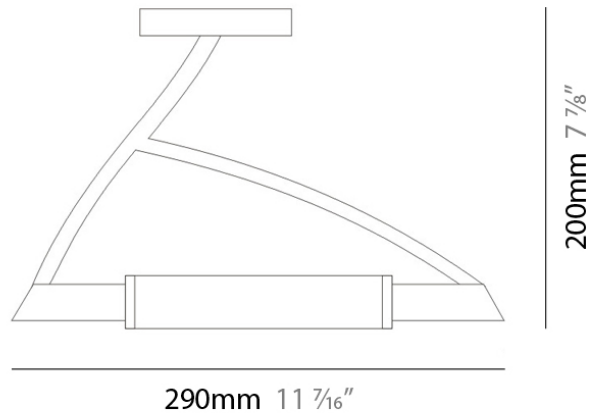

WINGS SURFACE

D83033

GENERAL

Series: Wings _____
 Brand: Panzeri _____
 Division: Design _____
 Mounting Type: Surface _____
 Mounting Location: Wall _____
 Subcategory: Ambient _____

PHYSICAL

Shape: Abstract _____
 Length (mm): 290 _____
 Length (in): 11 ½ _____
 Height (mm): 160 _____
 Height (in): 6 ¼ _____
 Extension (mm): 190 _____
 Extension (in): 7 ½ _____
 Light Distribution: Omnidirectional _____
 Weight (kg): 1.23 _____
 Weight (lbs): 2.7 _____
 Diffuser: Matte White Printed Pyrex _____
 Fixture Finish: Chrome _____
 Fixture Material: Metal _____

ELECTRICAL

Number of Lamps: 1 _____
 Lamp Type: LED Retrofit / Halogen _____
 Lamp Shape: T3Q (119mm) _____
 Bulb Included: Bulb Not Included _____
 Total Output Wattage (W): 36 / 200 _____
 Max. Wattage Per Lamp (W): 36 / 200 _____
 Lamp Base: RSC _____
 Input Voltage (V): 120 _____

LED

OPTICAL

RATINGS AND CERTIFICATIONS

Certified By: CSA Certified to UL and CSA Standards _____
 IP rating: IP20 _____

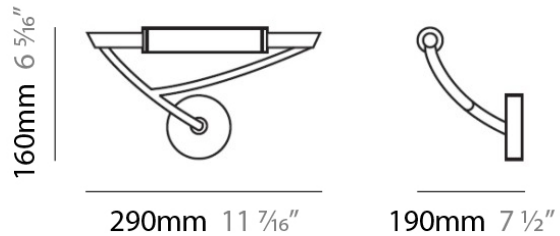

WINGS SURFACE

D83035

GENERAL

Series: Wings _____
 Brand: Panzeri _____
 Division: Design _____
 Mounting Type: Surface _____
 Mounting Location: Wall _____
 Subcategory: Ambient _____

PHYSICAL

Shape: Abstract _____
 Length (mm): 290 _____
 Length (in): 11 ½ _____
 Height (mm): 160 _____
 Height (in): 6 ¼ _____
 Extension (mm): 190 _____
 Extension (in): 7 ½ _____
 Light Distribution: Omnidirectional _____
 Weight (kg): 1.23 _____
 Weight (lbs): 2.7 _____
 Diffuser: Matte White Printed Pyrex _____
 Fixture Finish: Chrome _____
 Fixture Material: Metal _____

ELECTRICAL

Number of Lamps: 1 _____
 Lamp Type: LED Retrofit _____
 Lamp Shape: T3 _____
 Bulb Included: Bulb Not Included _____
 Total Output Wattage (W): 20 _____
 Max. Wattage Per Lamp (W): 20 _____
 Lamp Base: RSC _____
 Input Voltage (V): 120 _____

LED

OPTICAL

RATINGS AND CERTIFICATIONS

Certified By: CSA Certified to UL and CSA Standards _____
 IP rating: IP20 _____

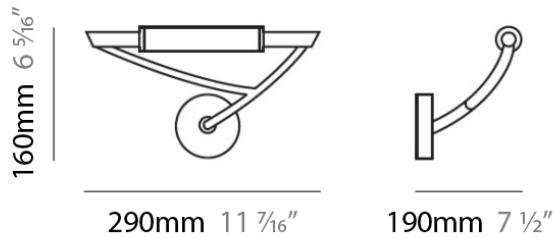

WINGS SURFACE

D83036

GENERAL

Series: Wings _____
 Brand: Panzeri _____
 Division: Design _____
 Mounting Type: Surface _____
 Mounting Location: Wall _____
 Subcategory: Ambient _____

PHYSICAL

Shape: Abstract _____
 Length (mm): 290 _____
 Length (in): 11 1/2 _____
 Height (mm): 160 _____
 Height (in): 6 1/4 _____
 Extension (mm): 190 _____
 Extension (in): 7 1/2 _____
 Light Distribution: Omnidirectional _____
 Weight (kg): 1.23 _____
 Weight (lbs): 2.7 _____
 Diffuser: Matte White Printed Pyrex _____
 Fixture Finish: Metallic Gray _____
 Fixture Material: Metal _____

ELECTRICAL

Number of Lamps: 1 _____
 Lamp Type: LED Retrofit / Halogen _____
 Lamp Shape: T3 _____
 Bulb Included: Bulb Not Included _____
 Total Output Wattage (W): 28 / 200 _____
 Max. Wattage Per Lamp (W): 28 / 200 _____
 Lamp Base: RSC _____
 Input Voltage (V): 120 _____

LED

OPTICAL

RATINGS AND CERTIFICATIONS

Certified By: CSA Certified to UL and CSA Standards _____
 IP rating: IP20 _____

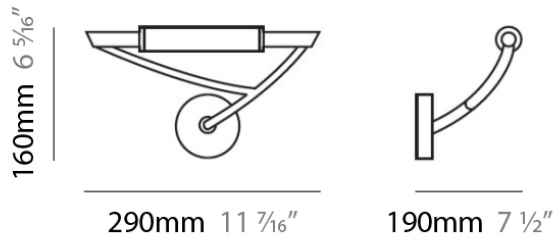

| | |
|----------|-------|
| PROJECT | _____ |
| TYPE | _____ |
| NOTES | _____ |
| QUANTITY | _____ |
| DATE | _____ |

WINGS SURFACE

D83060

GENERAL

Series: Wings
Brand: Panzeri
Division: Design
Mounting Type: Surface
Mounting Location: Wall
Subcategory: Sconce

PHYSICAL

Shape: Abstract
Length (mm): 210
Length (in): 8 ¼
Height (mm): 120
Height (in): 4 ¾
Extension (mm): 150
Extension (in): 5 ⅞
Light Distribution: Omnidirectional
Weight (kg): 0.82
Weight (lbs): 1.80
Diffuser: Matte White Printed Pyrex
Fixture Material: Metal

ELECTRICAL

Number of Lamps: 1
Lamp Type: LED Retrofit
Lamp Shape: T3
Bulb Included: Bulb Not Included
Total Output Wattage (W): 23
Max. Wattage Per Lamp (W): 23
Lamp Base: RSC
Input Voltage (V): 120

LED





































































OPTICAL

RATINGS AND CERTIFICATIONS











Certified By: CSA Certified to UL and CSA Standards
IP rating: IP40













LEGEND

| | | | | | |
|--|---|---|--|---|--|
|  | floor-mounted |  | pivotal |  | special LED (upon request) RGB, RGBW, tunable, gold+, meat+, art+, fashion+ |
|  | wall and ceiling: recessed and surface mounted |  | rotating |  | warm dim / natural dimming LED |
|  | ceiling-mounted and wall-mounted |  | illuminate tilted |  | rechargeable battery powered |
|  | wall-mounted |  | color of suspension cable |  | fixture with natural vivid LED (upon request) |
|  | omni-directional light distribution |  | length of suspension cable |  | color rendering index |
|  | direct light distribution |  | reflector degree selection |  | color temperature |
|  | direct/indirect light distribution |  | super spot |  | lumen (luminous flux) |
|  | indirect light distribution |  | lens |  | efficacy (lumens per watt) |
|  | asymmetric light distribution |  | lens pack |  | Unified Glare Rating (UGR) range from 5-40 |
|  | aura light distribution |  | shine ring |  | marine grade (AISI 316 stainless steel) |
|  | round wall or ceiling cut-out |  | integrated shine ring with diffuser |  | walk on |
|  | square wall or ceiling cut-out |  | free individual colors 01-29 |  | drive on |
|  | the supplied jig specifies the cutout dimensions |  | individual colors: 00 (free of charge), 01-25 (extra charge) |  | Dark Sky Compliance |
|  | minimum distance (meters) lamp - object |  | luminaire part to be colored (F1) |  | Americans with Disabilities Act (less than 4" off the wall located between 27"-84" from floor) |
|  | recessed depth |  | luminaire part to be colored (F2) |  | lamp protected against explosion |
|  | ceiling thickness in mm |  | luminaire part to be colored (F3) |  | blown glass using traditional methods by master glass blower |
|  | ceiling thickness selection |  | luminaire part to be colored (F4) |  | acoustic material |
|  | dimmable DP (phase), DV (0-10V), DD (dali), DS (step-dim) |  | luminaire part to be colored (F5) |  | protection class I, protection insulation |
|  | included or excluded LED driver/transformer/control gear |  | color of 3-circuit adaptor |  | protection class II, protection insulation |
|  | separately switchable |  | indirect diffuser |  | ETL Certified to UL and CSA Standards |
|  | sensor |  | direct diffuser |  | UL Certified to UL and CSA Standards |
|  | remote control |  | ball-proof (upon request) |  | CSA Certified to UL and CSA Standards |
|  | available upon request |  | accessory |  | Certified for North American Standards |

IP RATING

| | |
|---|--|
|  | protected against ingress of solid bodies greater than 12.5mm (finger) |
|  | protected against ingress of solid bodies greater than 2.5mm protected against sprays of water up to 60 degrees from the vertical (rain) |
|  | protected against ingress of solid bodies greater than 1mm (wire) no protection against the ingress of moisture |
|  | protected against ingress of solid bodies greater than 1mm (wire) protected against sprays of water up to 60 degrees from the vertical (rain) |
|  | protected against ingress of solid bodies greater than 1mm (wire) protected against water splashed from all directions |
|  | protected against limited ingress of dust (wet rooms/covered outdoor areas) protected against water splashed from all directions |
|  | protected against ingress of dust protected against jets of water |
|  | protected against ingress of dust protected against powerful jets of water or heavy seas |
|  | protected against ingress of dust protected against immersion of water between 15cm - 1m for 30 minutes |
|  | protected against ingress of dust protected against immersion of water under pressure for long periods |

IK RATING

| | |
|---|---|
|  | protected against 0.14 joules impact (equivalent to 0.25kg mass dropped from 56mm above the surface) |
|  | protected against 0.2 joules impact (equivalent to 0.25kg mass dropped from 80mm above the surface) |
|  | protected against 0.35 joules impact (equivalent to 0.25kg mass dropped from 140mm above the surface) |
|  | protected against 0.5 joules impact (equivalent to 0.25kg mass dropped from 200mm above the surface) |
|  | protected against 0.7 joules impact (equivalent to 0.25kg mass dropped from 280mm above the surface) |
|  | protected against 1 joules impact (equivalent to 0.25kg mass dropped from 400mm above the surface) |
|  | protected against 2 joules impact (equivalent to 0.5kg mass dropped from 400mm above the surface) |
|  | protected against 5 joules impact (equivalent to 1.7kg mass dropped from 300mm above the surface) |
|  | protected against 10 joules impact (equivalent to 5.0kg mass dropped from 200mm above the surface) |
|  | protected against 20 joules impact (equivalent to 5.0kg mass dropped from 400mm above the surface) |